

PERSONALSCOPE™ HP55

manual



velleman®

<http://www.velleman.be>

**ELECTRONICS
MADE
EASY**

Velleman
Legen Heirweg 33
9890 Gavere
Belgium
Internet Site: <http://www.velleman.be>
E-mail: support@velleman.be

HHPS5 - 1999 - ED1

CONTENTS

FCC information for the USA	4		
Important.....	5		
GENERAL	6		
Features.....	5		
Options.....	5		
Technical specifications.....	6		
SAFETY and WARNINGS.....	7		
Symbols displayed on the unit.....	7		
USE.....	8		
Survey of the connections and controls	8		
Power supply	9		
Survey of the indications on the screen	10		
OPERATION.....	11		
Turning on/off the Personal Scope	11		
Resetting the Personal Scope.....	11		
Adjusting the contrast.....	11		
Choice of input	11		
Switching from one readout to another.....	12		
Measuring probe adjustment	13		
Auto-setup function	13		
Signal screen	14		
Screen memory.....	15		
Set-up function keys.....	15		
The markers	15		
Setting up the voltage per division	16		
Setting up the time base.....	15		
		Moving the signal in Y-position.....	16
		Trigger functions	17
		Setting up a X10 measuring probe	18
		MAINTENANCE.....	18
		TROUBLESHOOTING	19
		The screen remains blank or there is no signal.....	19
		RMS readout is incorrect	19
		No signal on the oscilloscope display	19
		Incorrect frequency readout.....	19
		Voltage readout is not correct	19
		WARRANTY	19
		DIAGRAM.....	20

FCC information for the USA

This equipment has been tested and found to comply with the limits for a Class B digital device, pursuant to Part 15 of the FCC Rules. These limits are designed to provide reasonable protection against harmful interference in a residential installation. This equipment generates, uses and can radiate radio frequency energy and, if not installed and used in accordance with the instructions, may cause harmful interference to radio communications. However, there is no guarantee that interference will not occur in a particular installation. If this equipment does cause harmful interference to radio or television reception, which can be determined by turning the equipment off and on, the user is encouraged to try to correct the interference by one or more of the following measures:

- Reorient or relocate the receiving antenna.
- Increase the separation between the equipment and receiver.
- Connect the equipment into an outlet on a circuit different from that to which the receiver is connected.
- Consult the dealer or an experienced radio/TV technician for help.

Important

This equipment was tested for FCC compliance under conditions that include the use of shielded test leads between it and the peripherals. It is important that you use shielded cables and connectors to reduce the possibility of causing Radio and Television interference. **Shielded probes, suitable for the HPS5 oscilloscope can be obtained from the authorized Velleman dealer.**

If the user modifies the HPS5 oscilloscope or its connections in any way, and these modifications are not approved by Velleman, the FCC may withdraw the user's right to operate the equipment.

The following booklet prepared by the Federal Communications Commission may be of help: "How to identify and Resolve Radio-TV Interference problems". This booklet is available from the US Government Printing Office, Washington, DC20402 Stock No. 044-000-00345-4.

GENERAL

The Velleman PersonalScope is not a graphical multimeter but a complete portable oscilloscope at the size and the cost of a good multimeter. Its high sensitivity - down to 5mV/div - and extended scope functions make this unit ideal for hobby, service, automotive and development purposes. Because of its extreme value for money, the PersonalScope is well-suited for educational use in schools and colleges. Suitable for measurements on audio equipment, mains voltage applications, digital signals, all kind of sensors, signal analysis in automotive applications, car stereo etc... It's ultra fast full auto setup function takes care of all the necessary settings and makes measuring waveforms very easy, a feature that will be appreciated both by experts and novices.

Features

- High contrast LCD with wide viewing angle
- Full auto set up for volt/div and time/div
- Trigger mode: run - normal - once - slope -/+
- True RMS and dB measurements
- Readout: Vdc-Vpp-Vrms-dBm
- x1 and x10 probe calculation option
- Display mode: none - markers - grid - crosshair
- Marker readout: dt - 1/dt (frequency) - dV
- AC/DC input coupling selection
- Automatic zero reference for DC measurements
- Screen hold function
- Auto power off or continuous on
- Low battery detection
- Includes battery charge circuit

Options

- Insulated measurement probe x1 / x10: PROBE60S
- Soft carry case: CHPS5
- Adapter: type PS905 for 230V / PS905USA for 110V

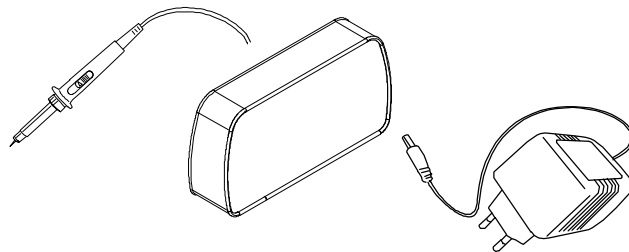

Technical specifications

Maximum sample rate	5MHz for repetitive signals (0.5MHz for single shot events)
Input amplifier bandwidth	1MHz (-3dB at 1V/div setting)
Input impedance	1Mohm // 20pF (standard oscilloscope probe)
Maximum input voltage	100Vpeak (AC + DC)
Input coupling	DC, AC and GND (GND for auto zero reference)
Vertical resolution	8 bit (6 bit on LCD)
Linearity	± 1bit
LCD Graphics	64 x 128 pixels, 64 x 96 pixels for signal
dBm measurement (0 dB= 0.775V)	From -73dB tot +40dB (up to 60dB with X10 probe) ±0.5dB accuracy
True-rms AC measurement	From 0.1mV to 80V (up to 400Vrms with X10 probe) 2.5% accuracy
Peak peak and DC range	0.1mV to 180V (1mV to 600V met x10 probe) 2% accuracy
Timebase range	20s, 10s, 5s, 2s, 1s, 0.5s, 0.2s, 0.1s, 50ms, 20ms, 10ms, 5ms, 2ms, 1ms, 0.5ms, 0.2ms, 0.1ms, 50us, 20us, 10us, 4us, 2us / div.
Input sensitivity range (at x1)	5mV, 10mV, 20mV, 50mV, 0.1V, 0.2V, 0.4V, 1V, 2V, 4V, 8V, 20V /div.
Probe calibration output	Approx. 1KHz / 5Vtt
Supply voltage	9VDC/ min 300mA adapter (unregulated) 12VDC if regulated
Batteries (option)	Alkaline type AA or Ni Cd / NiMH rechargeable (5 pcs required)
Charge current for rechargeable batteries	90mA
Battery life	Up to 20h with Alkaline batteries
Operating temperature	0 to 50°C (32 to 122°F)
Dimensions	105x220x35mm (4.13x7.95x1.38")
Weight	395g (14oz.) ex. Batteries

SAFETY and WARNINGS**Symbols displayed on the unit**

Important safety information, see user manual.



Ground level

- ⇒ The PersonalScope is ideally suited for measurements of category II installations with pollution degree 1 and using a maximum of 600V, in accordance with the IEC1010-1 norm. The enclosure is UL 94V0 listed
- ⇒ Consequently, all measurements should be avoided in case of polluted or very humid air. One should also refrain from measuring conductors or installations that use voltages that exceed 600Vrms above ground level. CAT II indicates conformity for measurements of domestic installations.
- ⇒ The maximum input voltage for the connections of the unit stands at 100Vp (AC+DC)
- ⇒ Do NOT open the enclosure while performing measurements.
- ⇒ Remove all test leads before opening the enclosure in order to avoid electrical shock.
- ⇒ Use a measuring probe with an insulated connector (e.g. type PROBE60S) when measuring voltages exceeding 30V.



Remove all non-rechargeable batteries when connecting an AC/DC adapter !

USE

Survey of the connections and controls

- 1 - BNC input connector (max. input 100Vp AC+DC)
- 2 - Adapter connection (observe the polarity!)
- 3 - Battery compartment
- 4 - X10 probe testing signal behind battery cover
- 5 - Serial number
- 6 - Display
- 7 - Battery charge indication LED
- 8 - Reset push button
- 9 - Keyboard

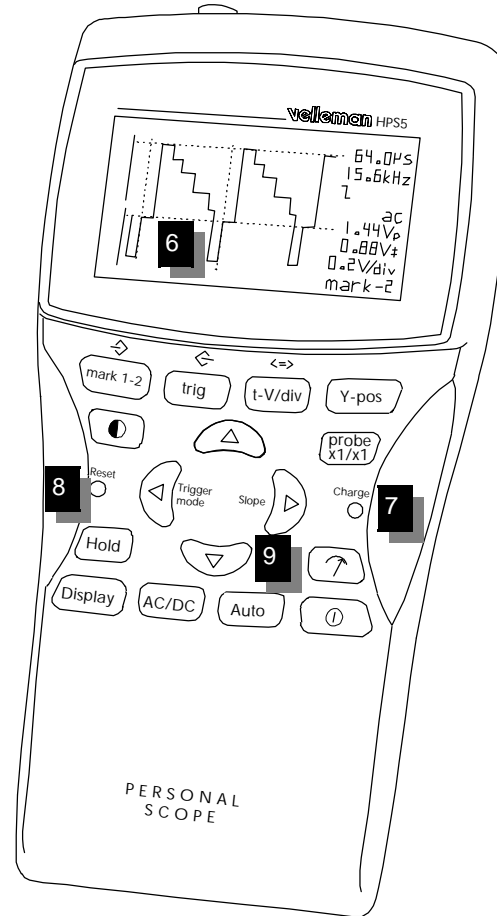
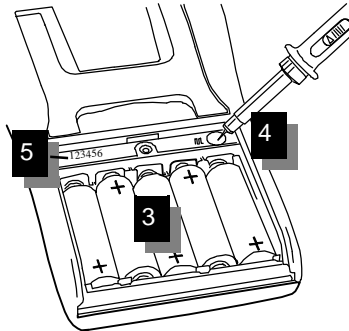
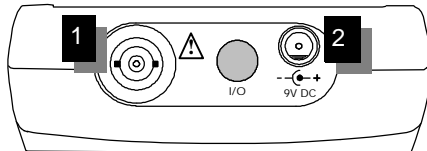

Power supply

The HPS5 PersonalScope can be powered by means of an adapter, ordinary batteries or rechargeable ones.

Rechargeable batteries are advised for intensive use.

The greater the capacity of the rechargeable batteries, the greater the autonomy of the unit.

Rechargeable batteries of the 500mA/h type will yield approx. 5 hours of autonomy, while 800mA/h-types provide up to 8 hours of autonomy.

Attention:

- ⇒ Use a non-regulated adapter of 9VDC that supplies a min. of 300mA. Observe the polarity and consult your retailer if necessary.
- ⇒ When using a regulated adapter, the user should verify whether it can supply 12VDC.

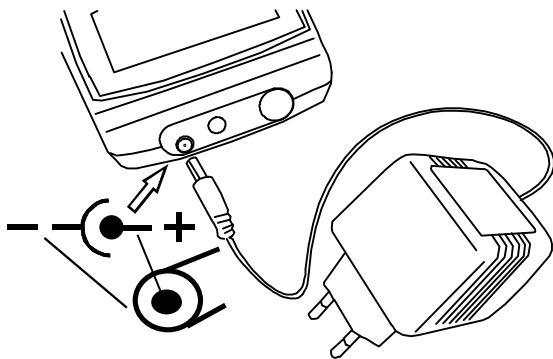

Batteries (option):

- ⇒ The unit can be used with either ordinary alkaline batteries or rechargeable ones e.g. our HR6 type (5 x).
- ⇒ Open the battery cover by loosening the screw:

Insert the batteries in the holders. Mind the polarity !

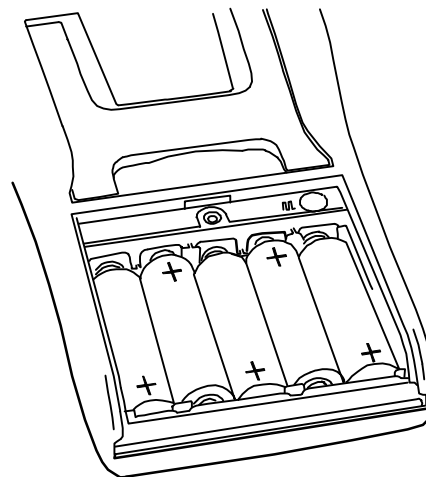

**Important:**

Do NOT perform measurements unless the battery compartment is closed. The battery cover should only be removed for the calibration of the probe's X10-position.

- ☞ When first using the rechargeable batteries or if the batteries are completely discharged, the user should charge them for at least 12 hours before using the unit.
- ☞ When the unit is OFF, the charging time for 800mA/h type batteries will be approx. 12 hours.
- ☞ The “Charge” indication LED on the front panel will light up when the batteries are being charged.

ATTENTION: Remove all non-rechargeable batteries when connecting the AC/DC adapter !

The message “Lo . bat” will flash in the bottom right corner of your display when the batteries need replacement (or charging). Insufficient battery voltage may entail erroneous measuring results.

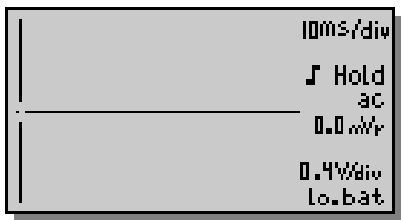

neous measuring results.

**Survey of the indications on the screen :**

Dot indicates the vertical position of the signal on the screen

Trigger opening indication (fixed in the middle of the screen)

Signal window with (possibly) the markers , cross or dot to indicate the various divisions.

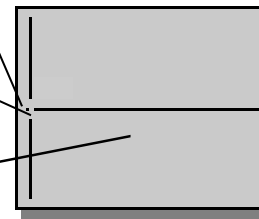

- Time per division or time between markers (when used)
- Display of converted/calculated frequency 1/dt between markers (if present)
- Trigger information or screen hold indication.
- Input-coupling indication : ac/dc/gnd and X10 probe setup
- Measurement readouts, Vp (V peak-to-peak) ; Vr (Volt rms) ; dB (Decibels) ; V= (DC volt.)
- Readout of the voltage between the markers (when present)
- Selected voltage per division
- Indication of the selected function (blue keys) or battery-low indication

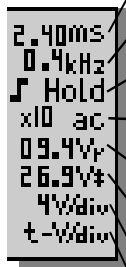

OPERATION

Turning on/off the Personal Scope

Press the “ON/OFF” switch briefly to (de)activate the unit. The screen will briefly display the logo above the message “timer on”, which means that the unit will deactivate after eight minutes if no other key has been pressed during this interval.

In order to bypass automatic deactivation : Keep the ON/OFF switch pressed down while activating the unit. The screen will briefly display the message “timer off”.

 When the unit is deactivated, the last setup will be saved as long as the power is not cut and as long as the unit is not “reset” (see below).

Resetting the Personal Scope.

In case of unusual behaviour of the keypad or the display, it is possible to reactivate the unit by using the "Reset" function. The unit will subsequently return to the manufacturer-programmed setup.

Press the sunk “Reset” push button for at least 10 seconds.

 Do not use a sharp tool !

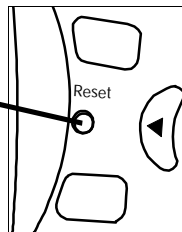

Adjusting the contrast

Press the “contrast” key until the desired contrast is displayed.

The user can either keep the key pressed down or press it repeatedly.

When pressing this key, the contrast will always increase to maximum level before starting again at the lowest available level and working its way up again

Choice of input

Depending on (part of) the signal to be measured, the input can be connected to the signal through a direct link or by using a decoupling capacitor.

Select DC for measuring DC voltage.

Press the “AC/DC” key to select either AC or DC input coupling (see indications on the screen).

 When measuring the “ripple” of a DC voltage : put the input on AC to limit the measurement to the AC component of the signal.



Switching from one readout to another

The Personal Scope offers many voltage measuring possibilities.

Press the “readout” key repeatedly to select one of four possible readouts :

Peak voltage (Vp). The signal's peak-to-peak voltage (difference between highest and lowest value) is displayed.

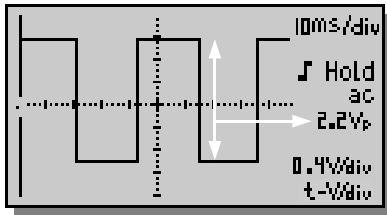

True RMS readout (Vr). The area of the AC wave is calculated and converted to voltage. Please remember that a correct readout invariably consists of at least one or two visible periods (one can also use the auto-setup function).

dB measurement (dB). The measured signal is converted to dBm (0dB=0.775V). Once more, the user should make sure that at least one or two periods are displayed or select the auto-setup function).

DC voltage measurement (V=). This function enables the user to measure DC voltages (only for DC input coupling)



Useful tip for measuring DC voltages:

The readout can be set at zero (reference) for any position on the screen by keeping the AC/DC key pressed down. Always use the "run" trigger mode for DC voltage measurement.

NOTE: If the signal goes off-screen or when the dB-signal is too small for measurement, the display will show....



probe
x1/x10

Measuring probe adjustment

We advise the user to use a measuring probe equipped with a X10 setting when high or unknown voltages or high impedances need to be measured. When using the measuring probe in the X10 position, the measuring impedance will increase to 10Mohm, thereby

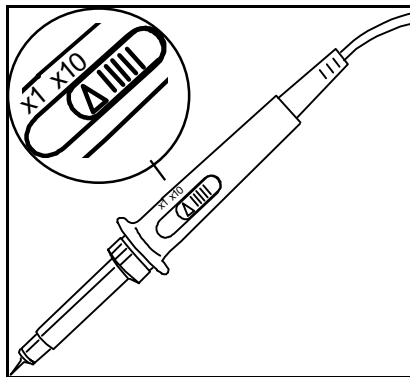

reducing the measuring instrument's charge on the coupling.

Press the "x1/x10" key in order to adjust the display to the setup of the measuring probe.

Upon choosing X10, "X10" will be indicated on the

screen and all measuring values will be adjusted accordingly.

IMPORTANT : X10 measuring probes should be calibrated. Read "Setting up a X10 measuring probe".

Auto

Auto-setup function

The auto-setup function is ideally suited for quick measurements as no manual setup has to be made and everything is automatic.



Use the auto-setup function when the screen no longer displays a signal after the manual setup.

- Connect the signal to be checked to the BNC input by means of a special measuring lead or measuring probe.
- Activate the unit.
- Press "Auto" in order to (de)activate the auto-setup function.

When "auto setup" is engaged, the Volt/div and Time/div readouts are highlighted.

The auto setup function will provide correct measurements for repetitive and stable signals of max. 400KHz.

The display may read as follows :

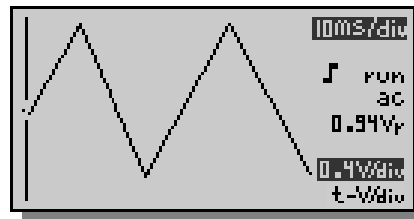



IMPORTANT: Put the appropriate measuring probe in the X10 position for measuring high voltages (>100Vp + DC).

NOTE:

- ⇒ The Y-position does not work in auto-setup, which is why the trigger setup remains in run or normal mode.
- ⇒ The auto-setup function will deactivate when using the Trigger, Volt and time per division and Y position functions. (see further).

Display

Signal screen

The signal screen is an aid in displaying the divisions on your screen or in positioning movable markers on the screen.

Press the “Display” key repeatedly in order to engage the various aids:

- A grid divides the screen into reference points.
- A cross inserts a co-ordinate system into the screen.
- Markers: Moveable markers in order to measure the signal (see below for use).
- Empty : no aids.

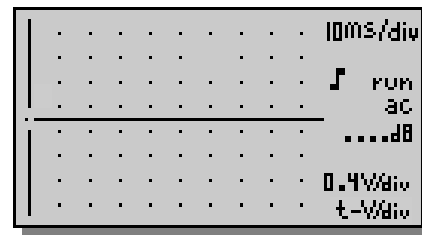

GRID

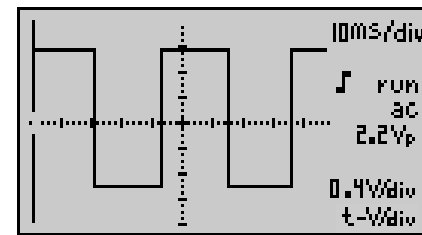

CROSSHAIR

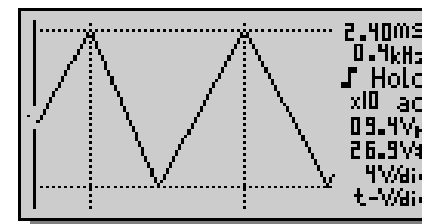

MARKERS

Hold **Screen memory**

It may be useful to "freeze" certain signals on your screen. This will allow the user to study the signal or perform measurements with the markers.

Press 'Hold' to freeze the screen.

☞ The screen is also saved when the unit is deactivated.

☞ The memory will be erased if "reset" is pressed or if the battery voltage is too low.

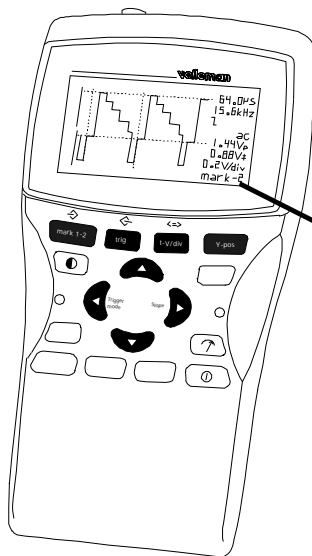

Set-up function keys

The selected function is displayed in the bottom right hand corner of the screen.

The four blue function keys work in conjunction with the arrow keys.

mark 1-2 **The markers**

The user can perform measurements on a certain signal by using the four moveable markers.

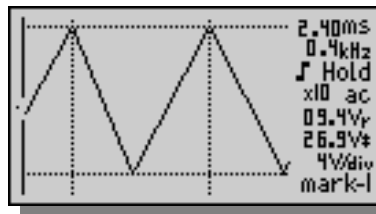

This can be useful when measuring the interval between two points or the amplitude of any given peak.

The following indications will appear on the screen :

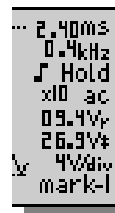

- ☞ The time interval between two vertical markers.
- ☞ The calculated frequency (primarily used for the measurement of periods).
- ☞ The voltage between two horizontal markers.

The markers can be moved through the arrow keys. Keeping the key pressed down will move the marker quickly, pressing it briefly will move the marker by 1 position. The "mark 1-2" key is used to select the desired marker.

☞ Determining the frequency of a signal requires the measurement of a period. The easiest way to do this would be by placing the vertical markers either on two consecutive peaks or two identical slopes of a signal.

t-V/div **Setting up the voltage per division**

The user can enlarge or reduce the signal on the screen vertically by adjusting the displayed voltage per division. (V/div = voltage per division). The divisions can be made visible through the Display key (see page 16).

Press the "t-V/div" key

Press the **Y** or the **B** key to select the sensitivity : from 5mV to a maximum of 20V per division.

☞ 50mV to 200V with X10 probe selection

t-V/div **Setting up the time base**

Adjusting the time base will visualise more or fewer periods of a signal (t/div = time per division). The divisions can be visualised through the Display key (see page 16).

Press the "t-V/div" key

Press the **U** the **D** key to set the time base between 20s and 2μS per division.

ATTENTION : the positions 10μs, 4μs and 2μs only operates correctly with periodic signals, for which the unit will automatically select the 'normal' trigger mode. The

screen will be adjusted once the trigger level is reached.

NOTE: Use the minimum time base (2 microsec) as a starting point when measuring a signal and select longer time bases until the signal is displayed properly. Otherwise the display may not correctly reflect the signal under measurement due to aliasing.

Y-pos **Moving the signal in Y-position**

Press the "Y-pos" key

Press the **Y** key or the **B** key in order to move the signal in the direction of the arrows. Prolonged pressing will make the Y- position change faster. A small dot in the left-hand corner of the screen will indicate the direction in which the signal has moved. In this manner, the user will know in which direction the signal was going when it went off-screen.

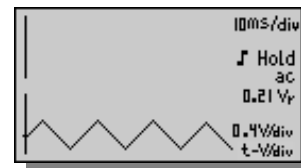
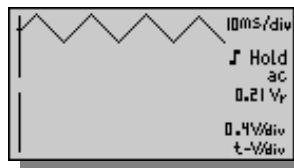



Trigger functions

The Personal Scope is equipped with a number of "trigger" aids that are used when the signal can be displayed on-screen.

Press the "trig" key.

The **U** (trigger mode) key enables the user to select the appropriate triggering method, the **P** (slope) key is used to select the trigger slope (see below).

Press the **U key repeatedly to choose between :**



"run" mode: The signal will always appear on the screen, regardless of the level involved. This position is used most frequently and should always be used for measuring DC voltages in particular.



"norm" mode: The screen will be adjusted provided that the signal falls within the trigger level (interruption in the vertical line on the left-hand side of your screen). Use this mode when you want to start displaying the signal when it reaches a preset threshold value.



"once" mode: The screen is adjusted **one single time**, viz. when the trigger level is reached. Use this mode to detect e.g. a short, once-only voltage peak.

ATTENTION : in the positions 10µs, 4µs and 2µs the unit will automatically select the 'norm' trigger mode. The trigger level has to be reached for the screen to be adjusted.



Both the **Y** and the **B** key remain active in order to move the signal along the Y-axis, which enables the user to programme a trigger reference

Repeatedly press the **P key to choose between :**

Triggering on the rising slope of the signal. The screen  will only display the signal when a positive slope is "detected", viz. the signal has to rise in vertical direction in order to trigger.

Triggering on the falling slope of the signal : The screen  will only display the signal when a negative slope is "detected", viz. the signal has to drop in vertical direction in order to trigger.

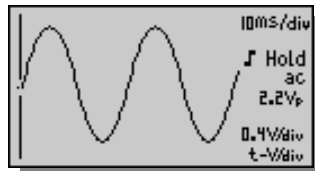

Trigger on rising slope

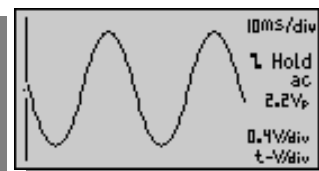

Trigger on falling slope

NOTE : There is a time difference of $\pm 12\mu s$ between the trigger point (the interruption in the vertical line on the left-hand side of the screen) and the start of the actual display. This is specifically true on higher frequencies.

Setting up a X10 measuring probe

When used in the X10 position, a measuring probe should always be calibrated to the measuring instrument being used, in this case the Personal Scope.

- Open the battery cover.
- Set the probe input to X10
- Set the voltage per division to 1V
- Set the time per division to 0.2ms
- Select AC for the input.

Use the probe to perform measurements at the preselected point under the battery cover

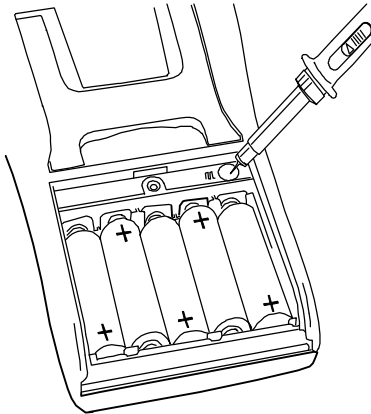

Adjust the trimmer of the measuring probe in order to obtain a square wave signal with a top that is as flat as possible.

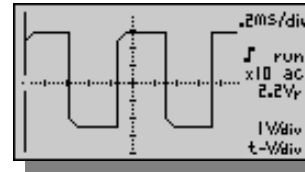

NG

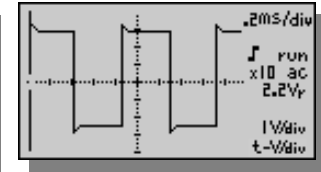

NG

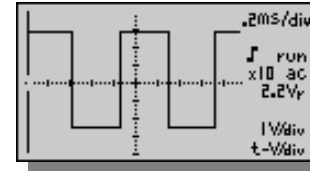

OK

MAINTENANCE

Clean the display with a shammy. NEVER use a dustcloth or paper in order to avoid scratches. The rest of the unit can be cleaned with a soft, dry cloth. NEVER use water to clean the unit.

TROUBLESHOOTING

The screen remains blank or there is no signal :

- No power supply
- Batteries are discharged
- Contrast adjustment is incorrect
- Press RESET for at least 10 seconds

REMARK: Temporarily remove both batteries and adapter in case RESET is not yet operational.

RMS readout is incorrect :

- Make sure that at least 1 and preferably even 2 periods are displayed.
- The batteries are discharged.

No signal on the oscilloscope display :

- Time/div setting is in the wrong position. Try 1ms or choose auto-setup mode.
- The unit is in the Hold position
- Trigger function is set in the “once” position
- The programmed trigger level is not reached (choose “run” mode)
- Y position is wrong
- The input signal is too high, change the volt/div. setting or choose auto-setup.

Incorrect frequency readout:

- An incorrect time/div. setting has been chosen. (start at 2 μ s)

Voltage readout does not correspond with the actual value :

- The measuring probe is in the X10 position
- The batteries are discharged
- The zero reference is not set correctly for DC measurements.
- Take into account that the RMS readout only measures the AC voltage

WARRANTY

This product carries a one-year warranty as far as the craftsmanship and possible flaws in the materials are concerned. The warranty expires **ONE YEAR** after the date of purchase.

The warranty will only apply if the unit is wrapped in the original packing material and either presented to VELLEMAN-KIT N.V. or to an official distributor together with a copy of the original purchasing document.

VELLEMAN-KIT N.V. is under the obligation to repair defects and flaws, but is free to either replace or repair defective parts.

The warranty does not apply to software, fuses, measuring probes and batteries. VELLEMAN-KIT N.V. will not be held responsible for any flaw or defect which the company feels is due to negligence on behalf of the user, to modification or opening of the unit, or to accidents or abnormal use or treatment of the product.

VELLEMAN-KIT N.V. will not reimburse the transport costs or risks, the costs for removing and replacing the product or any other costs that are directly or indirectly related to the defect. VELLEMAN-KIT N.V. accepts no liability for whatever damages may be caused by a malfunctioning product.

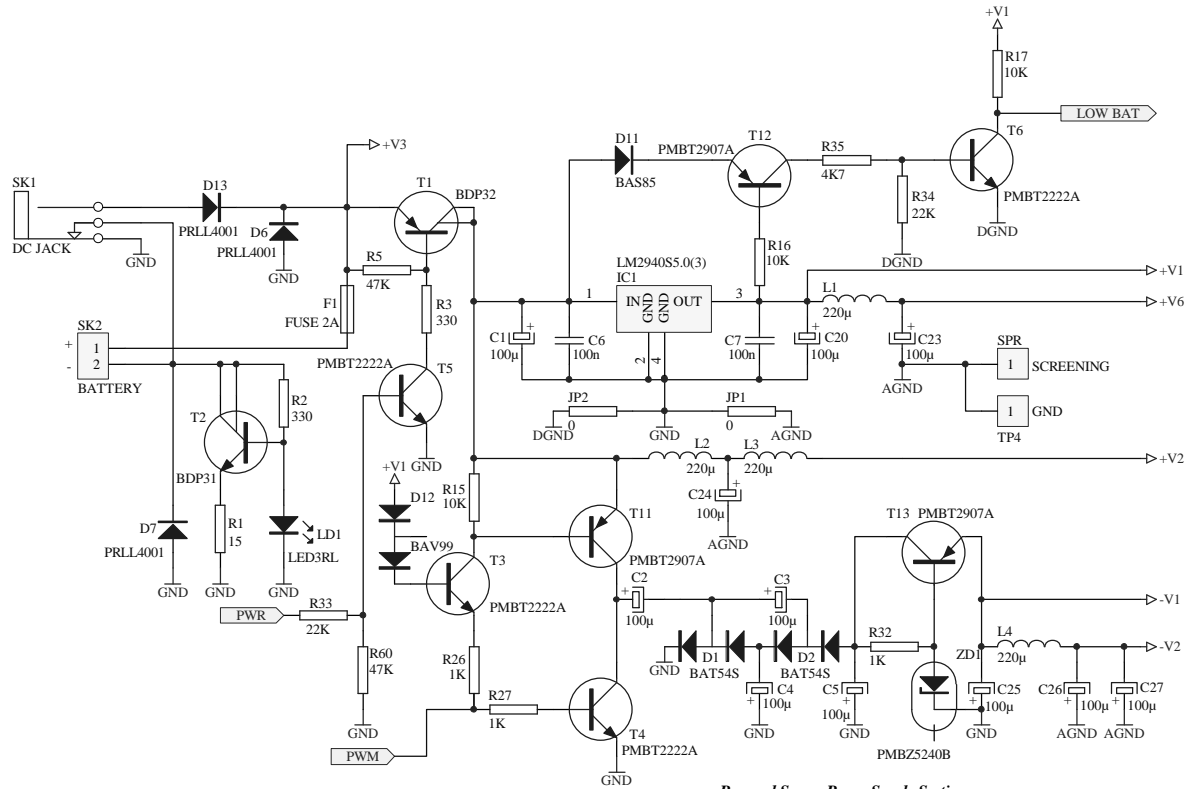

Personal Scope: Power Supply Section

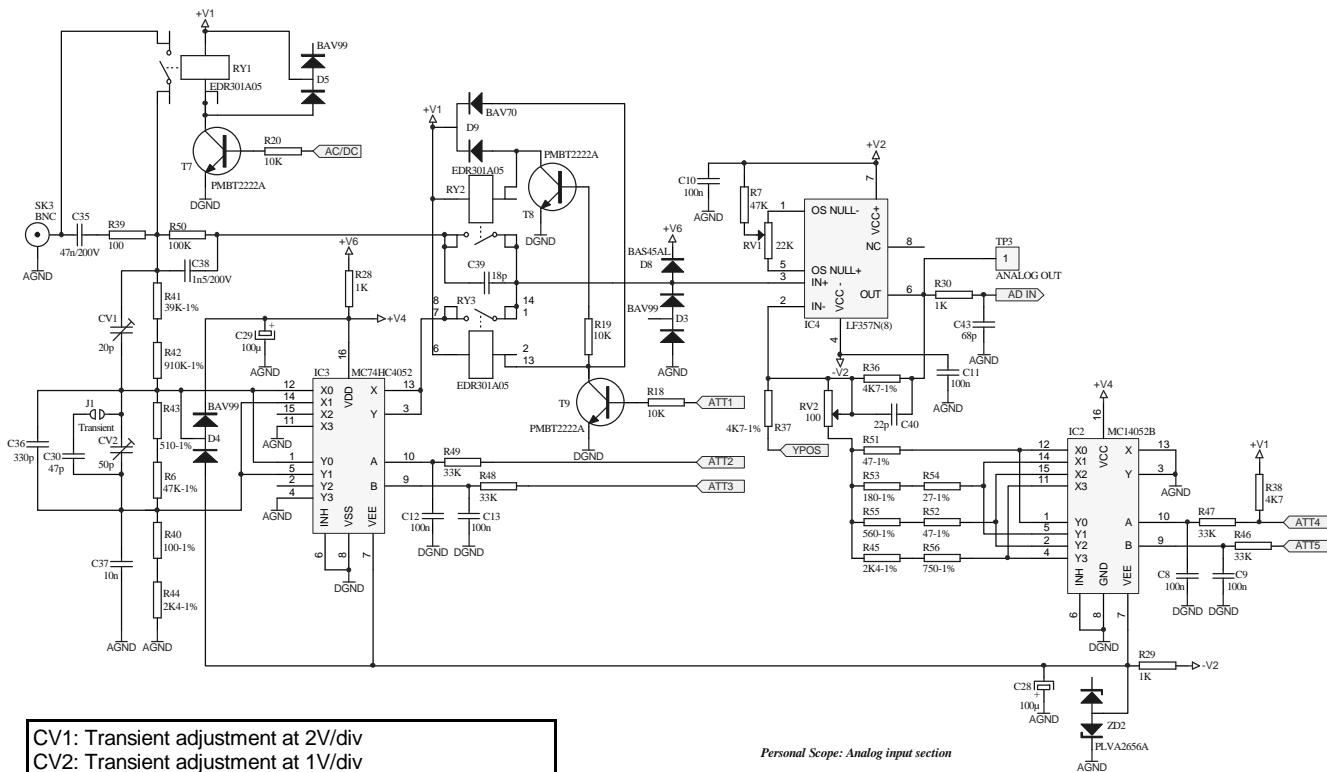

RV3: Calibration at 50mV/Div
 RV4: Center setting in auto setup mode

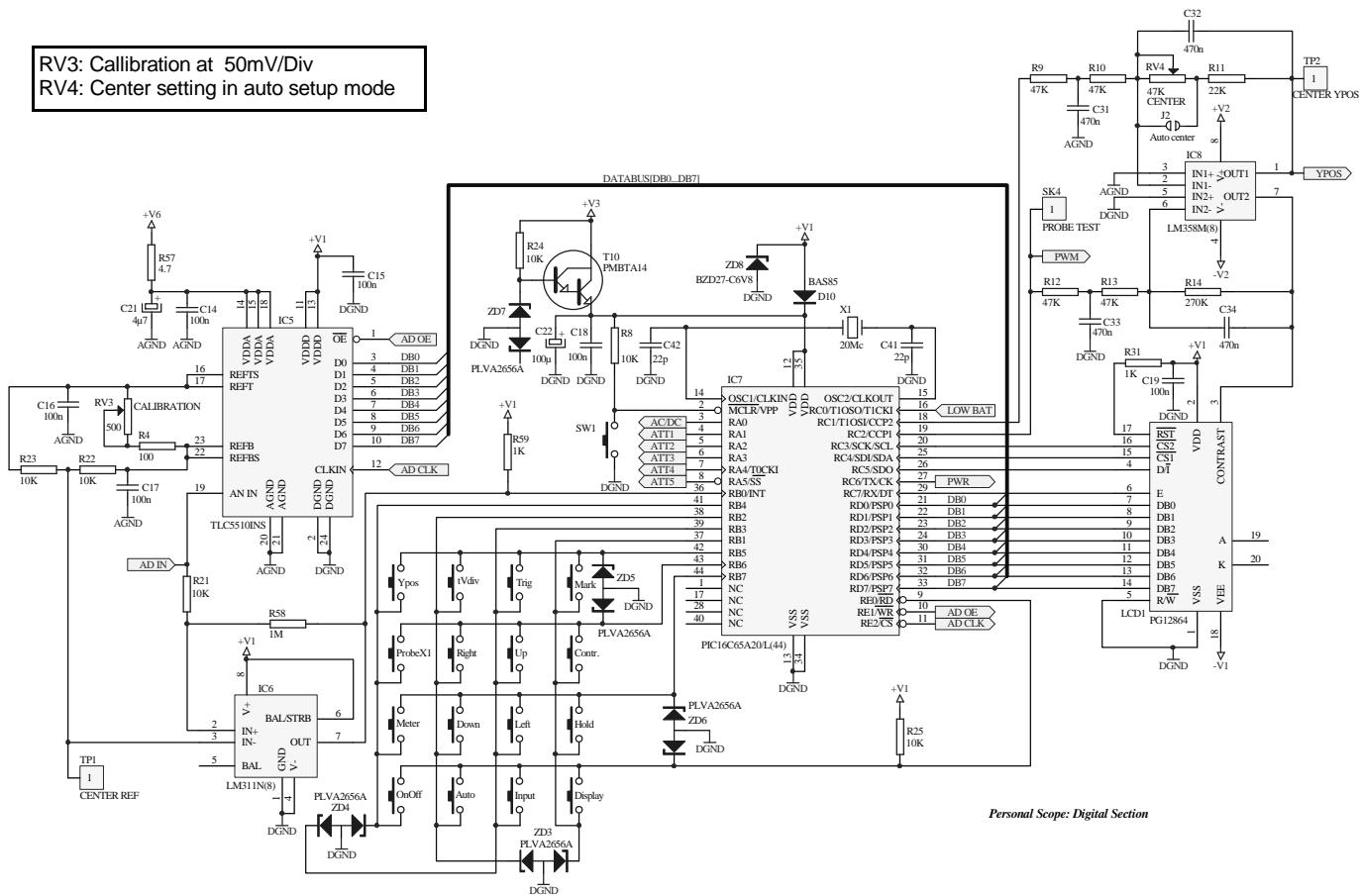

Personal Scope: Digital Section



Legen Heirweg 33, 9890 Gavere

Belgium Europe

+32 (0)9 3843611

<http://www.velleman.be>

HHPS5 - 1999 - ED1

France

VELLEMAN ELECTRONIQUE

+33 (0) 320158615

Netherlands

VELLEMAN COMPONENTS

+31 (0) 765147563

USA

VELLEMAN INC.

+1 (817) 284 7785